

THIS DRAWING IS UNPUBLISHED. RELEASED FOR PUBLICATION
 © COPYRIGHT - By - ALL RIGHTS RESERVED.

LOC	DIST	REVISIONS					
		P	LTR	DESCRIPTION	DATE	DWN	APVD
-	-		K4	REVISED PER ECO-11-004587	11MAR11	RK	HMR

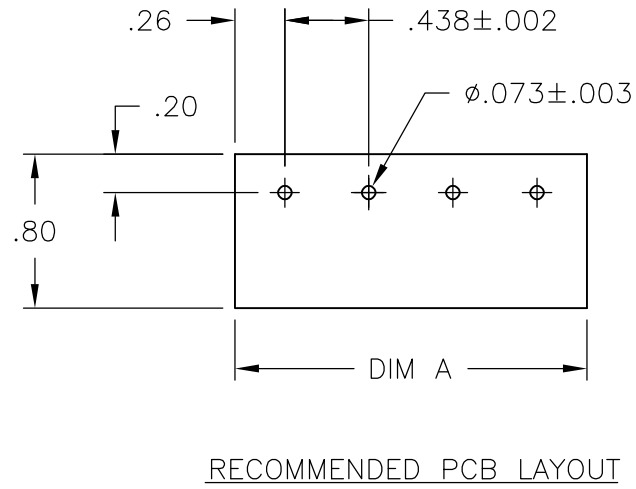
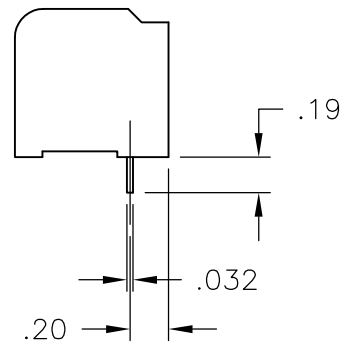
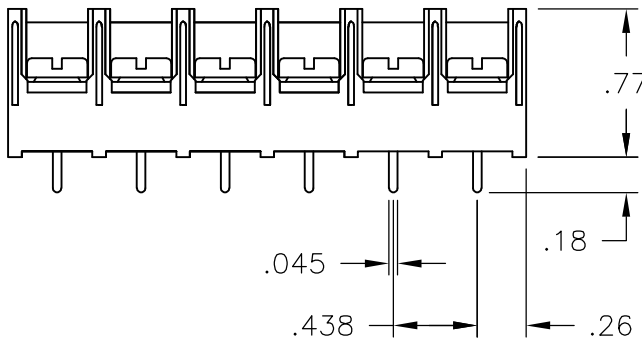
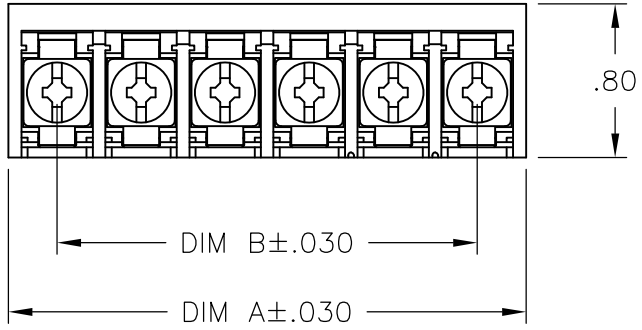

MATERIALS:
 HOUSING: THERMOPLASTIC, UL94V-0, BLACK.
 TERMINAL: BRIGHT TIN PLATED COPPER ALLOY.
 SCREWS: 8-32 ZINC PLATED STEEL.

ELECTRICAL:
 CURRENT RATING: 30A
 VOLTAGE RATING: 600V
 WIRE RANGE: 10-18 AWG (UL)
 10-22 AWG (CSA)

MECHANICAL:
 RECOMMENDED TORQUE: 20 IN-LB
 OPERATING TEMP.: -40°C TO +120°C.

- 1 MARK WITH WHITE INK.
- 2 M4 THREAD IN TERMINAL, NO SCREWS INCLUDED.
- 3 ALL SCREWS TO BE BOTTOMED, EXCEPT AS NOTED.
- 4 SCREWS ON THIS ASSEMBLY WIRE READY.

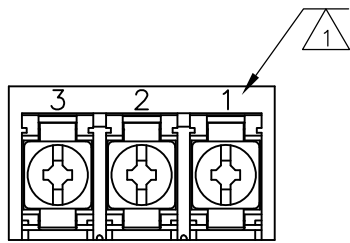

1546728-3

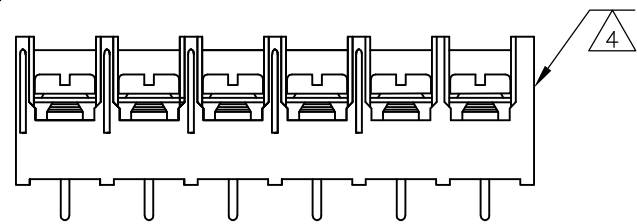

1986650-6

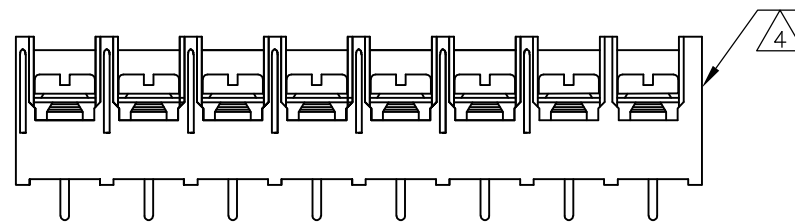

1986650-8

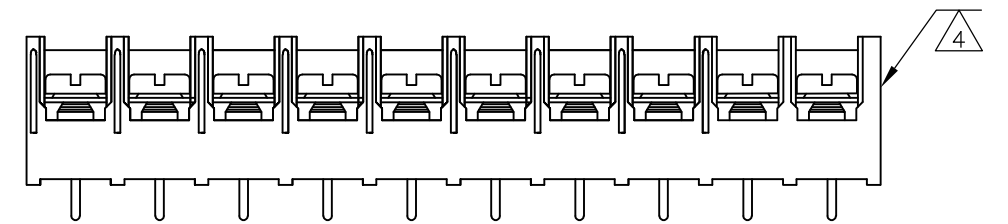

1-1986650-0

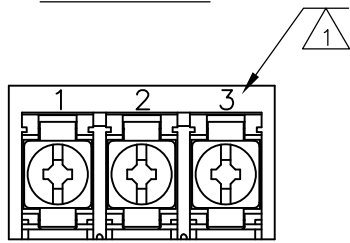

1546137-1

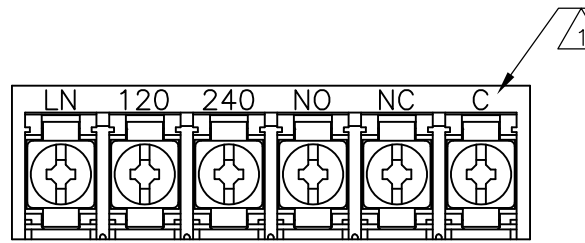

6-1546159-4

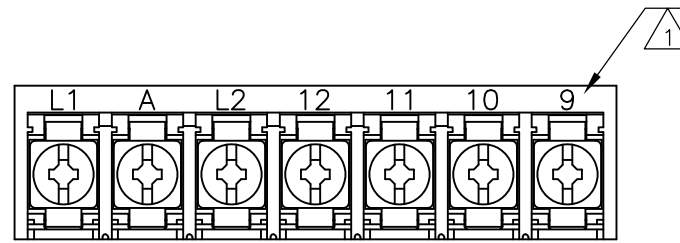

6-1546159-7

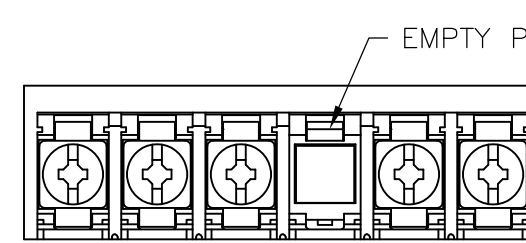

1546728-1

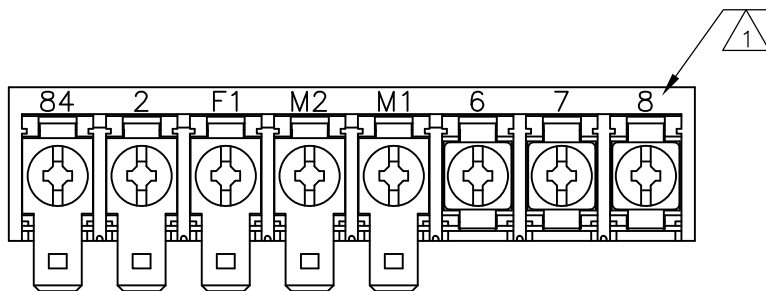

6-1546159-6

THIS DRAWING IS A CONTROLLED DOCUMENT.		DWN	S SCHLEGEL	5/15/03	STE TE Connectivity
DIMENSIONS: INCHES 		CHK	S YODER	5/15/03	
		APVD	S YODER	5/15/03	
MATERIAL		PRODUCT SPEC	NAME		
FINISH		APPLICATION SPEC	8PCV-XX-006 ASSEMBLY		
TOLERANCES UNLESS OTHERWISE SPECIFIED:		WEIGHT	SIZE		CAGE CODE
0 PLC	± -	-	A3		00779
1 PLC	± -	-	DRAWING NO		C-6-1437657-3
2 PLC	± .02	-	RESTRICTED TO		-
3 PLC	± .010	-	SCALE		NTS
4 PLC	± -	-	SHEET		1 OF 2
ANGLES	± -	-	REV		K4
FINISH	-	-	CUSTOMER DRAWING		

THIS DRAWING IS UNPUBLISHED. RELEASED FOR PUBLICATION
 © COPYRIGHT - By - ALL RIGHTS RESERVED.

LOC	DIST	REVISIONS					
		P	LTR	DESCRIPTION	DATE	DWN	APVD
-	-	-	-	SEE SHEET 1	-	-	-

REV	DESCRIPTION	DATE	DWN	APVD		
2	-	.875	1.385	3	-	1546728-5
-	-	8.312	8.822	20	8PCV-20-006	8-1546159-2
-	-	7.875	8.385	19	8PCV-19-006	1546728-2
-	-	7.438	7.948	18	8PCV-18-006	7-1437658-2
-	-	7.000	7.510	17	8PCV-17-006	8-1546159-1
-	-	6.563	7.073	16	8PCV-16-006	6-1437658-6
-	-	6.125	6.635	15	8PCV-15-006	8-1437659-0
-	-	5.688	6.198	14	8PCV-14-006	6-1437658-0
-	-	5.250	5.760	13	8PCV-13-006	5-1437658-5
-	-	4.813	5.323	12	8PCV-12-006	4-1437658-5
-	-	4.375	4.885	11	8PCV-11-006	4-1437658-0
-	-	3.938	4.448	10	8PCV-10-006	3-1437658-3
-	SEE FIGURE	3.938	4.448	10	8PCV-10-050	1-1986650-0
-	-	3.500	4.010	9	8PCV-09-006	7-1546159-1
-	SEE FIGURE	3.063	3.573	8	8PCV-08-502	6-1546159-9
-	-	3.063	3.573	8	8PCV-08-006	2-1437658-1
-	SEE FIGURE	3.063	3.573	8	8PCV-08-050	1986650-8
-	SEE FIGURE	2.625	3.135	7	8PCV-07-598	6-1546159-7
-	-	2.625	3.135	7	8PCV-07-623	1-1437658-6
-	-	2.625	3.135	7	8PCV-07-006	1-1437658-1
-	SEE FIGURE	2.187	2.697	6	8PCV-06-050	1986650-6
-	SEE FIGURE	2.187	2.697	6	8PCV-06-050	1546728-1
-	SEE FIGURE	2.187	2.697	6	8PCV-06-538	6-1546159-4
-	-	2.187	2.697	6	8PCV-06-006	9-1437657-8
-	SUPERCEDED BY 8-1437657-8	1.750	2.260	5	8PCV-05-637	9-1437657-4
-	-	1.750	2.260	5	8PCV-05-006	8-1437657-8
-	SUPERCEDED BY 8-1437657-0	1.312	1.822	4	8PCV-04-636	8-1437657-3
-	-	1.312	1.822	4	8PCV-04-006	8-1437657-0
-	SEE FIGURE	.875	1.385	3	8PCV-03-662	1546728-3
-	SEE FIGURE	.875	1.385	3	8PCV-03-657	1546137-1
-	-	.875	1.385	3	8PCV-03-006	6-1437657-9
-	-	.437	.947	2	8PCV-02-006	5-1437657-7
-	-	.437	.947	2	8PCV-02-634	6-1437657-3
COMMENTS	DIM B	DIM A	NO OF POS	CATALOG NUMBER	PART NO	

SUPERCEDED BY 8-1437657-8

SUPERCEDED BY 8-1437657-0

THIS DRAWING IS A CONTROLLED DOCUMENT.		DWN S SCHLEGEL 5/15/03	 TE Connectivity			
DIMENSIONS: INCHES		CHK S YODER 5/15/03				
		APVD S YODER 5/15/03	NAME			
TOLERANCES UNLESS OTHERWISE SPECIFIED:		PRODUCT SPEC	8PCV-XX-006 ASSEMBLY			
0 PLC ± -		APPLICATION SPEC	SIZE	CAGE CODE	DRAWING NO	RESTRICTED TO
1 PLC ± -			A3 00779		C-6-1437657-3	-
2 PLC ± .02			CUSTOMER DRAWING			
3 PLC ± .010		WEIGHT	SCALE		SHEET	REV
4 PLC ± -		-	NTS		2 OF 2	K4
ANGLES ± -						
FINISH						
MATERIAL						